

99841

Design

SKF Speedi-Sleeve Gold

Dimensions

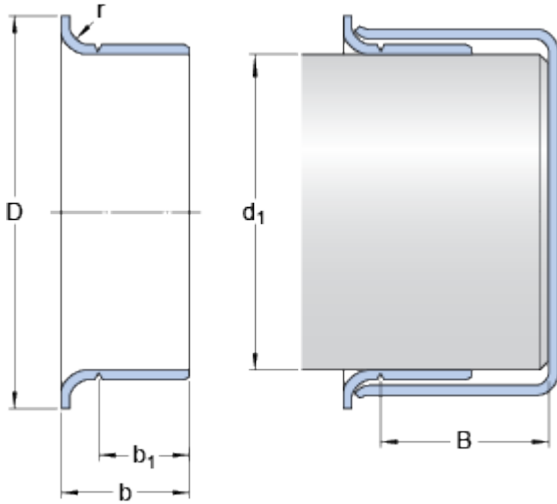

Nominal dimensions

d_1		65	mm
D		72.39	mm
Tolerance outside diameter D	±	1.6	mm
b		22.987	mm
Tolerance width b	±	0.8	mm
b_1		19.99	mm
Tolerance width b_1	±	0.8	mm
B	max.	34.925	mm
r	max.	3.18	mm

Shaft diameter range

d_1	min.	64.922	mm
d_1	max.	65.1	mm